

#103 - 19110 24 Avenue, Surrey, BC V3S 3S9
 T: 604.574.1233 F: 604.560.9554 E: info@altiumbuildingcorp.com
 www.altiumbuildingcorp.com

DRAWING TITLE:
 MECHANICAL SECRET
 FIX FC PARAPET

DETAIL NO.:
 3 OF 11

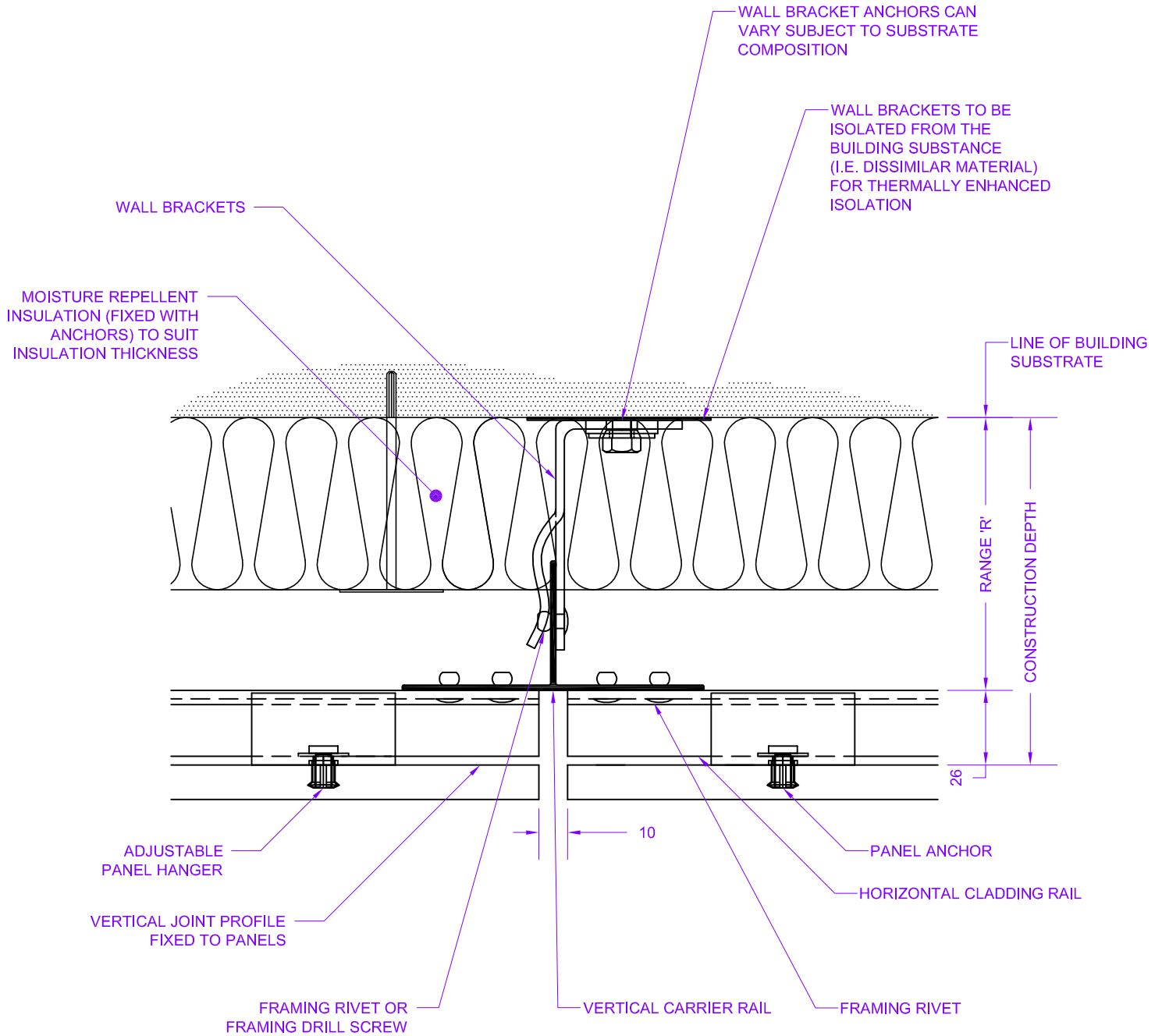

#103 - 19110 24 Avenue, Surrey, BC V3S 3S9
 T: 604.574.1233 F: 604.560.9554 E: info@altiumbuildingcorp.com
 www.altiumbuildingcorp.com

DRAWING TITLE:
 MECHANICAL SECRET
 FIX FC VERTICAL PANEL JOINT

DETAIL NO.:
 4 OF 11

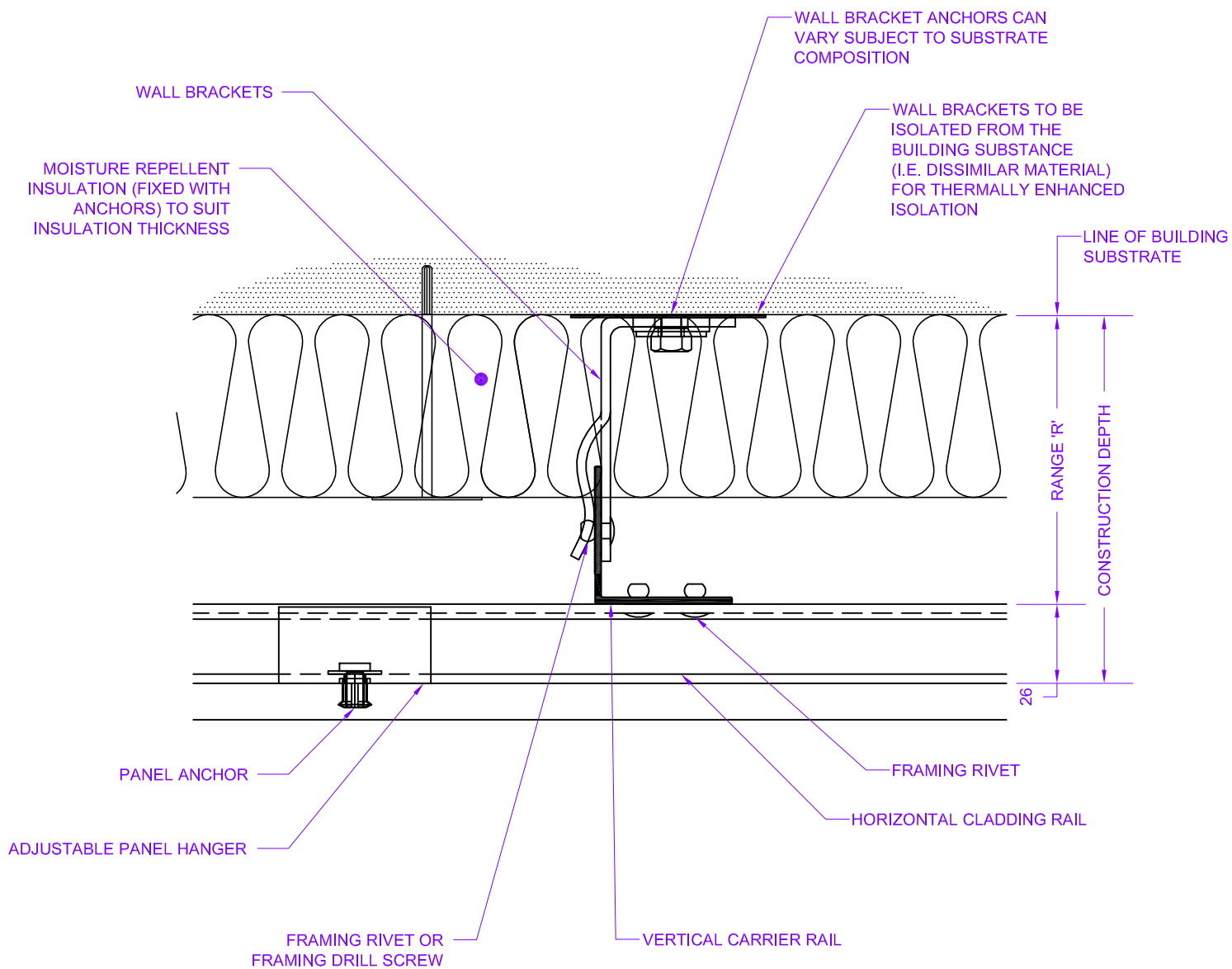

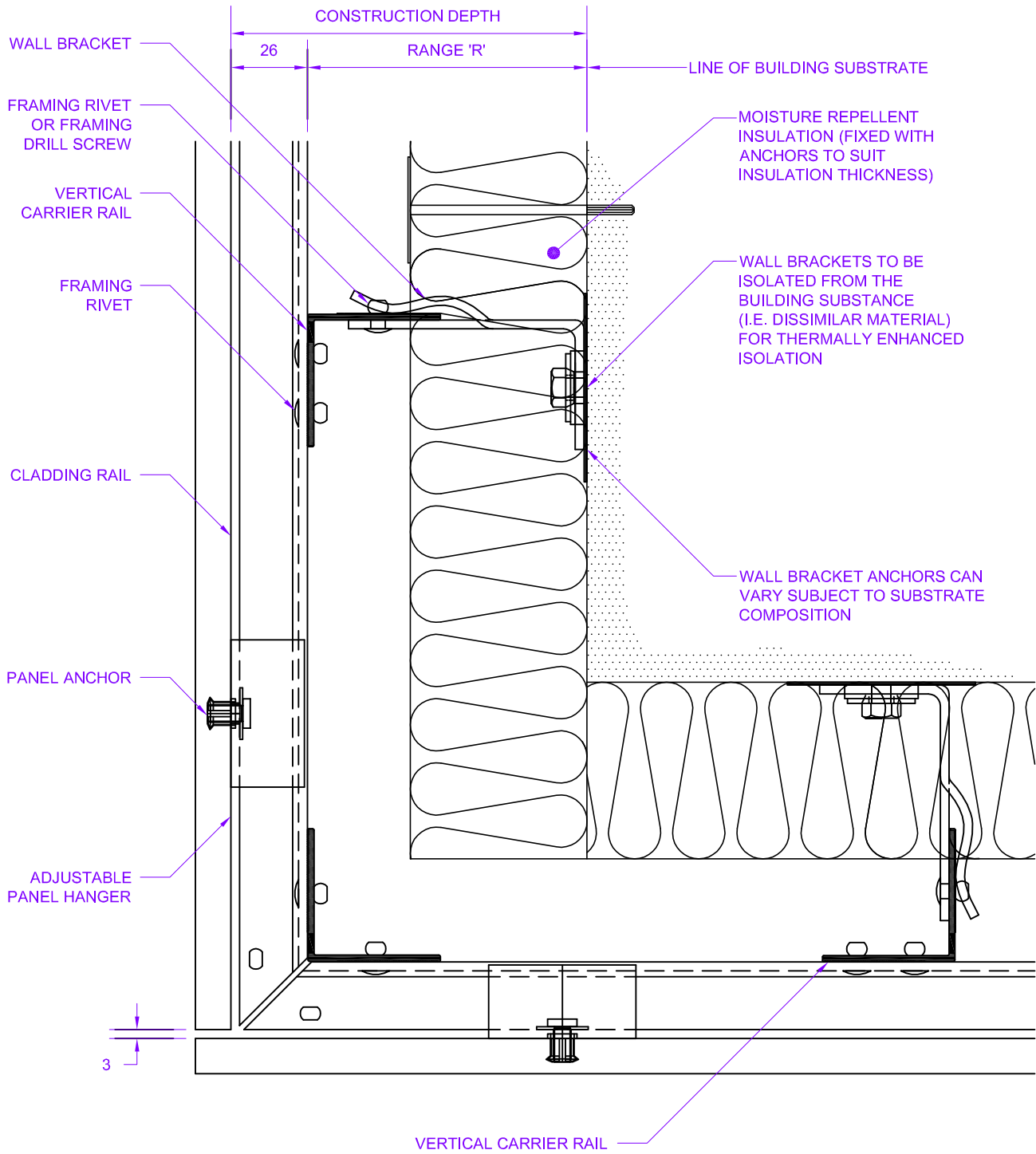

ALTUM BUILDING CORPORATION

#103 - 19110 24 Avenue, Surrey, BC V3S 3S9
 T: 604.574.1233 F: 604.560.9554 E: info@altiumbuildingcorp.com
 www.altiumbuildingcorp.com

DRAWING TITLE:
 MECHANICAL SECRET
 FIX FC EXTERNAL CORNER

DETAIL NO.:
 6 OF 11

NOTE: DETAILS REPRESENTED ARE PRELIMINARY AND GENERIC IN DESIGN AND MAY VARY FOR SPECIFIC APPLICATIONS

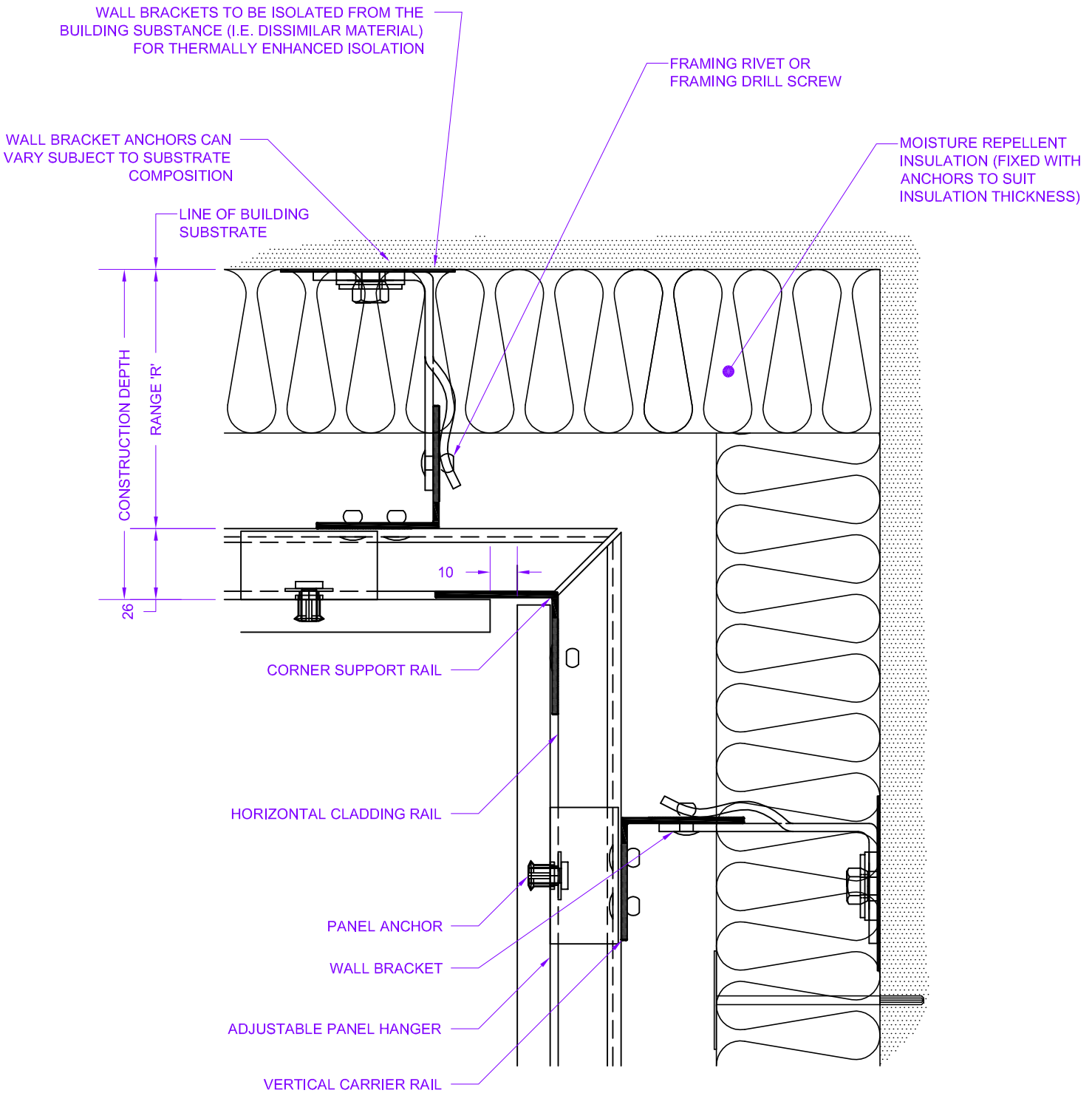

ALTUM BUILDING CORPORATION

#103 - 19110 24 Avenue, Surrey, BC V3S 3S9
 T: 604.574.1233 F: 604.560.9554 E: info@altiumbuildingcorp.com
 www.altiumbuildingcorp.com

DRAWING TITLE:
**MECHANICAL SECRET
 FIX FC INTERNAL CORNER**

DETAIL NO.:
7 OF 17

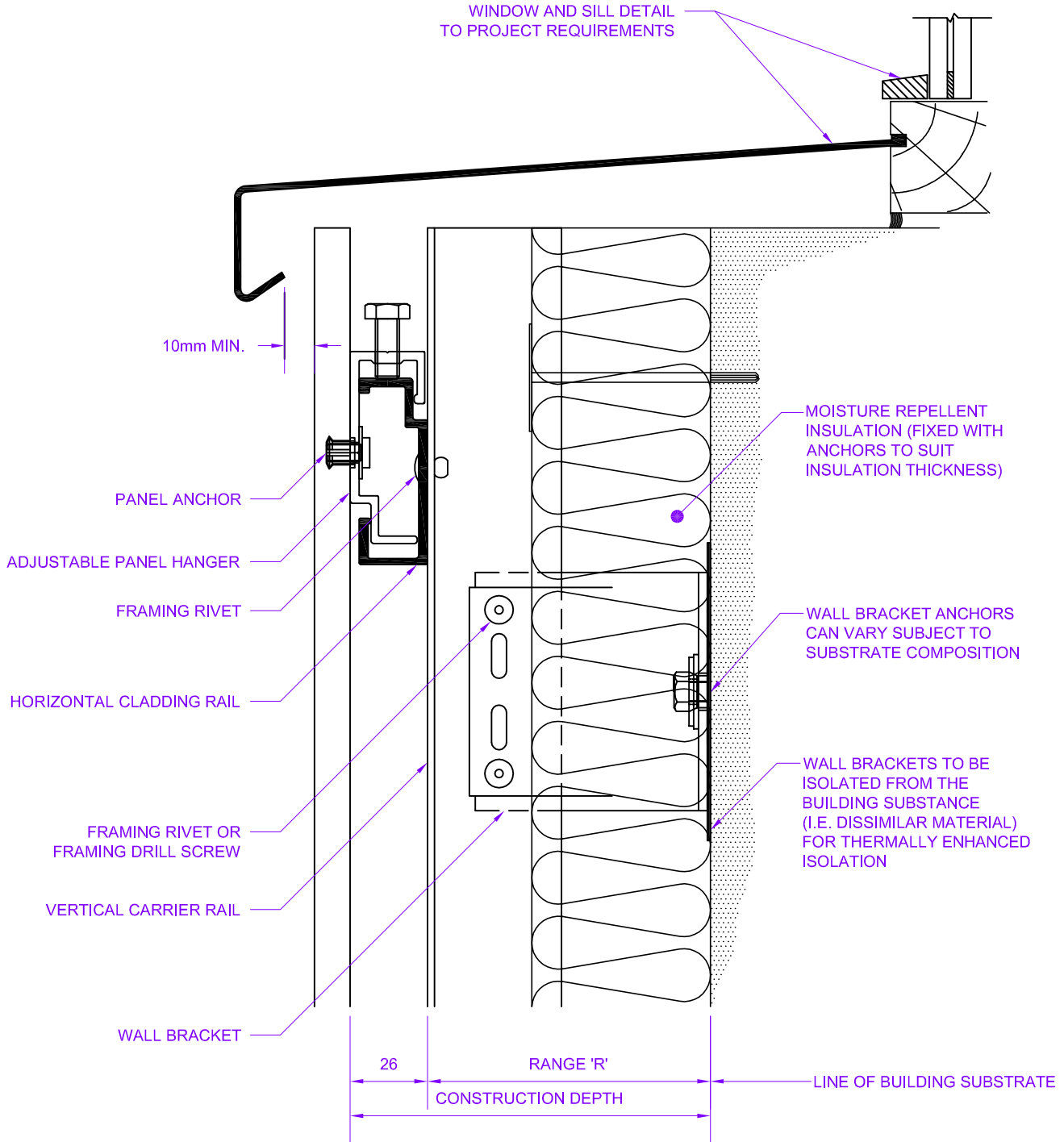

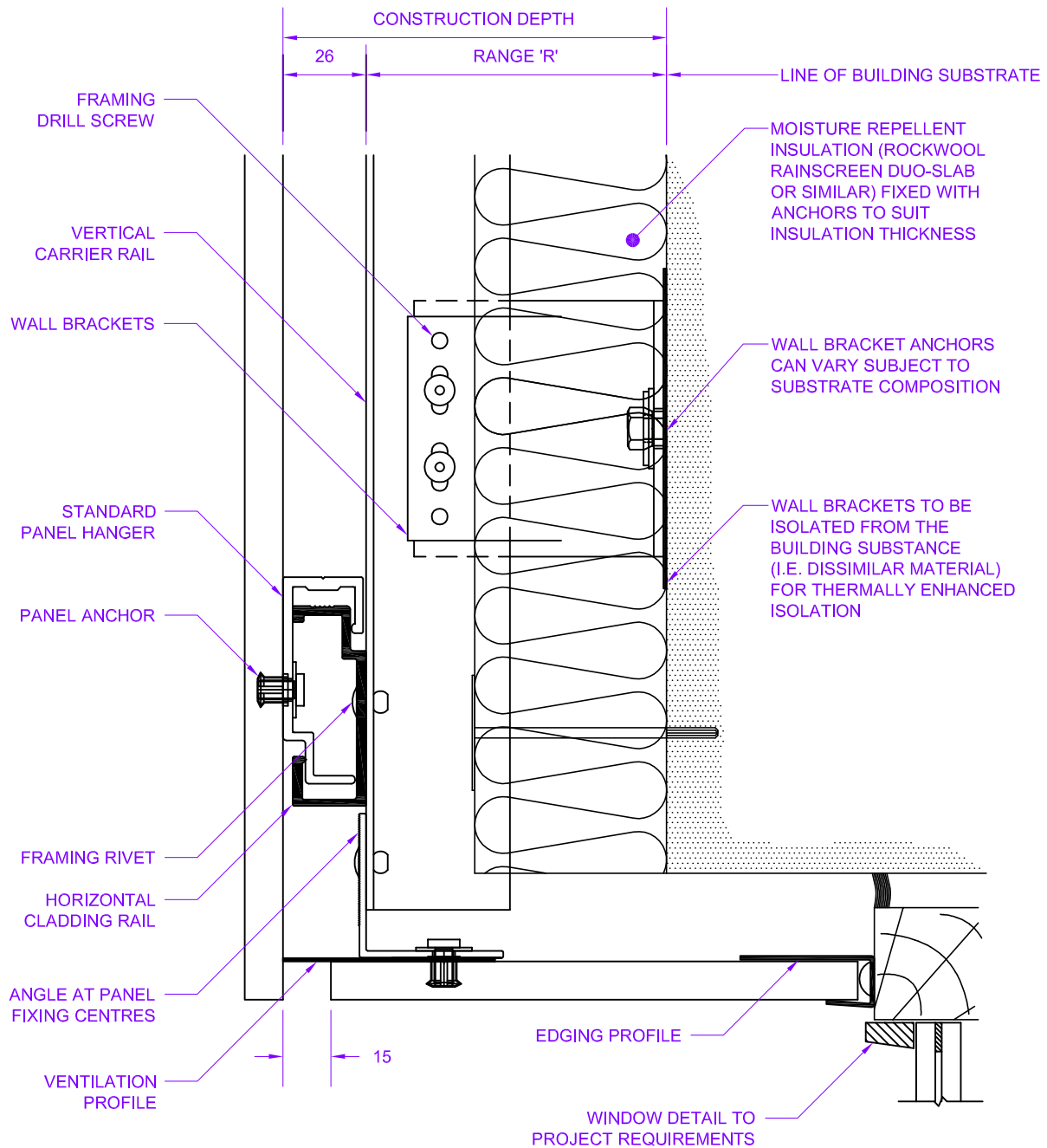

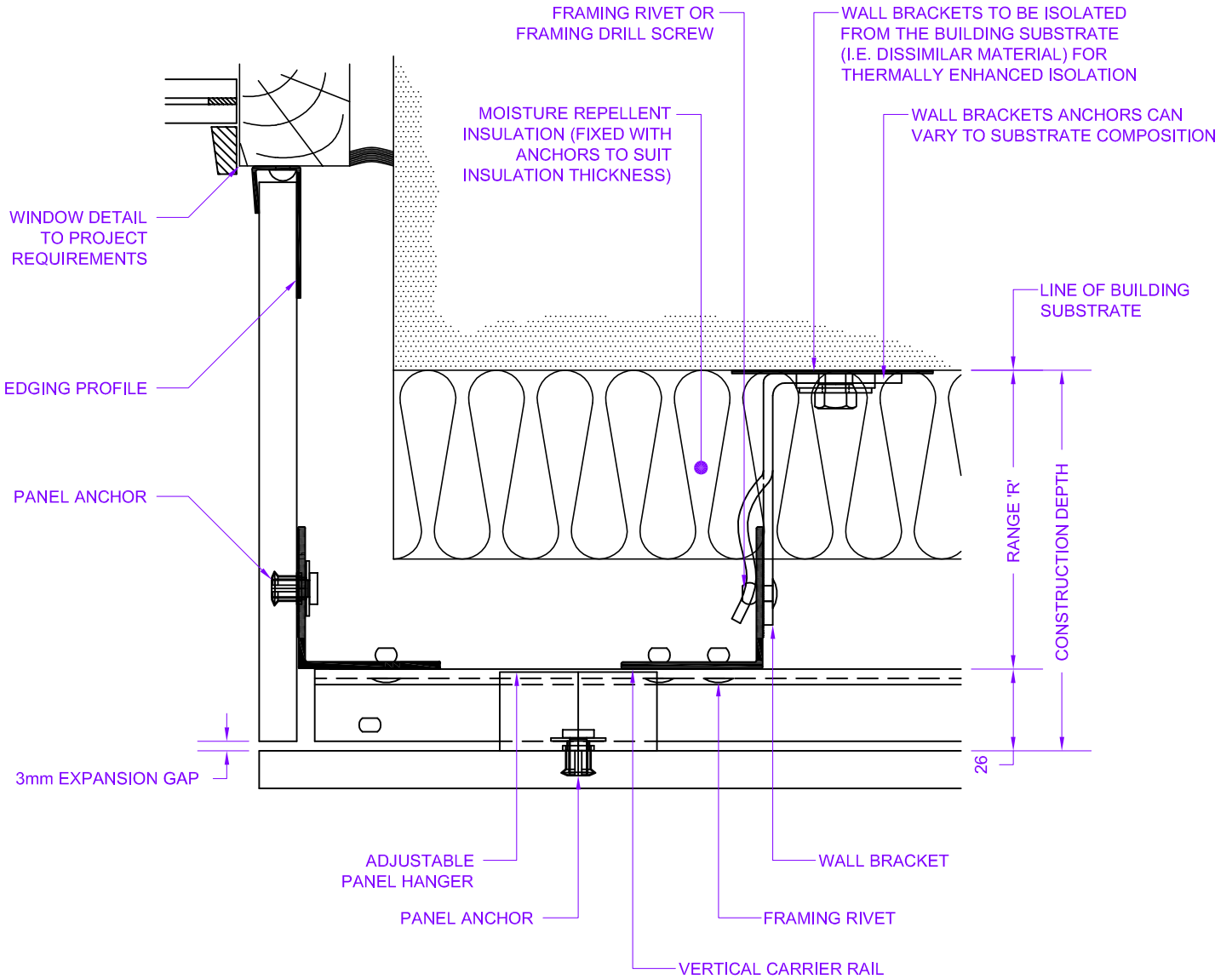

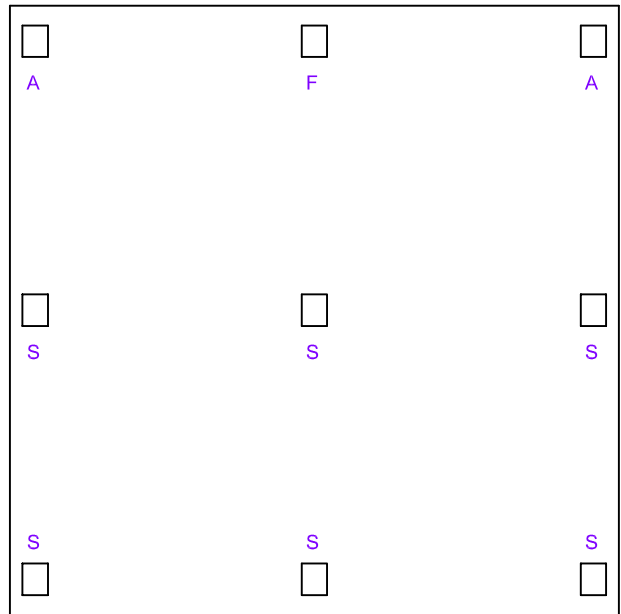
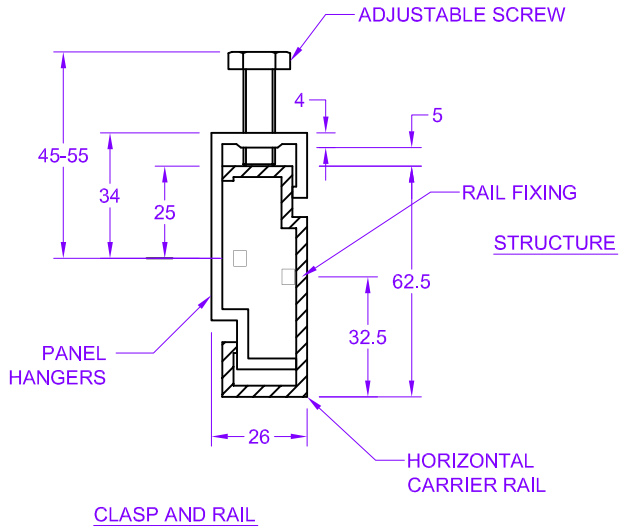

A = ADJUSTABLE
 F = FIXED
 S = STANDARD

CLASP LOCATIONS TO THE REAR OF THE BOARD

